

Crystal filters in metal packages

General application

Wireless communication systems, measurement equipment

Features

- Frequency 5 - 200MHz
- 2 - 12 poles
- Standard and custom filters
- A wide variety of other filter parameters (requirements of the pass- and stop-band, parasites, terminating impedance, intermodulation, group delay, reflection, linearities, etc.)
- We offer standard types of metal cases, custom cases for the filters can be used as well
- RoHS, PB-free



Examples of standard and custom filters in metal packages

Type	Fo [MHz]	Poles	Loss [dB]	Ripple [dB]	Bandwidth [kHz]	Stop band [dB]	Impedance [Ohm # pF]	Case
MCF 6.4-3.002	6.4	2	3.0	0.5	±1.5	30 ±15	4000 // 2.0	HC-49/3pin
KE 9.0-0.506	9.0	6	7.0	1.5	±0.25	60 ±0.8	50 // 0	KF 17
MCF 10.0-3.408	10.0	8	4.0	2.0	±1.7	80 ±6.0	1000 // 25	KF 17
MCF 10.0-7.602	10.0	2	1.0	1.0	±3.8	30 ±4.0	3900 // 2.0	HC-49/3pin
MCF 10.0-16.008	10.0	8	4.0	1.5	±8.0	80 ±25	9000 // -0.5	KV 5
KE 10.7-0.506	10.7	6	7.0	2.0	±0.25	60 ±0.8	50 // 0	KF 17
KE 10.7-1.005	10.7	5	4.0	1.5	±0.5	70 ±5.0	50 // 0	KF 17
MCF 10.7-2.408	10.7	8	5.0	2.0	±1.2	80 ±5.0	500 // 20	KV 5
MCF 10.7-2.410	10.7	10	6.0	2.0	±1.2	80 ±4.0	50 // 0	KF 17
MCF 10.7-5.010	10.7	10	5.0	1.5	±2.5	80 ±6.5	50 // 0	KF 17
MCF 10.7-7.5B	10.7	4	2.5	1.0	±3.75	40 ±14	1800 // 5.0	2xHC-49/3pin
MCF 10.7-7.510	10.7	10	5.0	2.0	±3.75	90 ±11	910 // 25	KF 17
MCF 10.7-12B	10.7	4	2.5	1.0	±6.0	40 ±20	3300 // 1.5	2xHC-49/3pin
MCF 10.7-13.06	10.7	6	4.0	1.5	±6.5	60 ±20	900 // 25	KF 17
MCF 10.7-15B	10.7	4	2.5	1.0	±7.5	40 ±25	3000 // 1.5	2xHC-49/3pin
MCF 10.7-151B	10.7	8	3.5	1.0	±7.5	80 ±22	50 // 0	KF 17
MCF 10.7-20.08	10.7	8	4.0	1.0	±10	80 ±28	50 // 0	KF 17
MCF 10.7-25.06	10.7	6	2.0	0.5	±12.5	60 ±35	900 // 25	KF 17
MCF 10.7-251B	10.7	8	3.5	2.0	±12.5	80 ±40	50 // 0	KF 17
MCF 10.7-2610	10.7	10	3.0	1.5	±13	80 ±25	910 // 25	KF 17
MCF 10.7-3210	10.7	10	4.0	1.5	±16	80 ±36	50 // 0	KF 17
MCF 10.7-40.06	10.7	6	6.0	1.5	±20	60 ±90	900 // 25	KF 17
MCF 10.7-5016	10.7	6	4.0	1.5	±25	60 ±80	50 // 0	KF 17
KE 10.7-10004	10.7	4	4.5	2.0	±50	60 ±300	50 // 0	KF 11.2
MCF 18.0-2.208	18.0	8	4.0	1.0	±11	80 ±35	50 // 0	KF 17
MCF 20.0-5A	20.0	2	1.0	1.0	±2.5	40 ±40	850 // 8.0	UM-1/3pin
MCF 21.4-6.910	21.4	10	5.0	2.0	±3.45	80 ±10	50 // 0	KF 17
MCF 21.4-7.012	21.4	12	4.5	2.0	±3.5	70 ±8.33	470 // 15	KF 17
MCF 21.4-7.5B	21.4	4	2.5	1.0	±3.75	40 ±14	850 // 5.0	2xUM-1/3pin
MCF 21.4-7.506	21.4	6	3.0	2.0	±3.75	65 ±12.5	850 // 5	KV 2.1
MCF 21.4-7.508	21.4	8	3.5	2.0	±3.75	90 ±12.5	850 // 5.0	KV 3
MCF 21.4-12B	21.4	4	2.0	1.0	±6.0	40 ±20	1200 // 2.5	2xUM-1/3pin
MCF 21.4-12.06	21.4	6	2.5	2.0	±6.0	65 ±20	1200 // 2.5	KV 2.1
MCF 21.4-1210	21.4	10	3.5	2.0	±6.0	90 ±16	1200 // 2.0	KV 3
MCF 21.4-15B	21.4	4	2.0	1.0	±7.5	40 ±25	1500 // 2.0	2xUM-1/3pin
MCF 21.4-15.06	21.4	6	3.0	2.0	±7.5	65 ±25	1500 // 2.0	KV 2.1
MCF 21.4-15.08	21.4	8	3.5	2.0	±7.5	90 ±25	1800 // 1.0	KV 3
MCF 21.4-1810	21.4	10	3.0	2.0	±9.0	90 ±25	1300 // 2.0	KV 3
MCF 21.4-20.06	21.4	6	2.0	1.5	±10.0	70 ±35	1500 // 1.0	KF 13
MCF 21.4-2010	21.4	10	4.0	1.0	±10.05	60 ±17.5	50 // 0	KF 17

Type	Fo [MHz]	Poles	Loss [dB]	Ripple [dB]	Bandwidth [kHz]	Stop band [dB]	Impedance [Ohm # pF]	Case
MCF 21.4-30B	21.4	4	2.0	1.5	±15	40 ±50	2200 // 0.5	2xUM-1/3pin
MCF 21.4-30.08	21.4	8	3.0	2.0	±15	80 ±50	2200 // 0.5	KV 2.1
MCF 21.4-46.08	21.4	8	4.0	2.0	±23	80 ±80	50 // 0	KF 17
MCF 21.4-50.08	21.4	8	4.0	2.0	±25	70 ±70	50 // 0	KF 13
KE 21.4-12006V4	21.4	6	9.0	1.5	±60	50 ±400	50 // 0	KF 17
KE 21.4-20009	21.4	6	8.0	1.5	±100	60 ±400	50 // 0	KF 17
MCF 21.65-39118	21.65	8	6.0	1.5	±19	80 ±70	50 // 0	KF 13
MCF 23.0-45118	23.0	8	5.0	2.0	±22.5	80 ±70	50 // 0	KF 13
MCF 24.0-6.006	24.0	6	3.5	2.0	±3.0	60 ±12.5	50 // 0	KF 13
MCF 25.0-7.008	25.0	8	5.0	1.5	±3.5	80 ±12.5	50 // 0	KF 17
MCF 32.6-2610	32.6	10	5.0	1.0	±13	80 ±25	50 // 0	KF 17
MCF 34.3625-3008	34.3625	8	5.0	2.0	±15	80 ±45	50 // 0	KF 17
MCF 35.25-2611	35.25	10	5.0	1.0	±13	80 ±25	50 // 0	KF 17.5
MCF 35.25-5006	35.25	6	5.0	2.0	±25	70 ±100	50 // 0	KF 13
MCF 35.25-5016	35.25	6	5.0	1.5	±25	70 ±100	50 // 0	KF 17.5
MCF 35.4-8.010	35.4	10	5.0	1.0	±4.0	80 ±20	50 // 0	KF 17
MCF 35.4-2610	35.4	10	5.0	1.0	±13	80 ±28	50 // 0	KF 17
MCF 37.4-6.006	37.4	6	5.5	2.0	±3.0	60 ±12.5	50 // 0	KF 13
MCF 44.85-1304	44.85	4	5.0	1.0	±6.5	70 ±50	50 // 0	KF 13
MCF 45.0-7.506	45.0	6	6.0	2.0	±3.75	50 ±12.5	350 // 5.0	KV 2.1
MCF 45.0-12BS1	45.0	4	3.0	1.0	±6.0	30 ±20	500 // 4.0	2xUM-5/3p-SMD
MCF 45.0-12.06	45.0	6	4.0	2.0	±6.0	60 ±20	500 // 4.5	KV 2.1
MCF 45.0-15BS1	45.0	4	3.0	1.0	±7.5	30 ±25	560 // 2.5	2xUM-5/3p-SMD
MCF 45.0-15.04	45.0	4	3.0	1.0	±7.5	30 ±25	650 // 3.0	2xUM-1/3pin
MCF 45.0-15.06	45.0	6	5.0	2.0	±7.5	60 ±25	650 // 3.0	KV 2.1
MCF 45.0-16.04	45.0	4	3.0	1.0	±8.0	30 ±25	700 // 2.0	2xUM-5/3pin
MCF 45.0-20.04	45.0	4	3.0	1.0	±10	35 ±40	800 // 2.0	2xUM-1/3p-SMD
MCF 45.0-30.08	45.0	8	3.5	2.0	±15	90 ±50	470 // 15	KF 13
MCF 70.0-6.606	70.0	6	5.0	2.0	±3.3	65 ±17.3	50 // 0	KF 17
MCF 70.0-1514	70.0	4	4.5	1.0	±7.5	40 ±40	50 // 0	KF 13
MCF 70.0-20.04	70.0	4	3.0	2.0	±10	35 ±40	3500 // -0.7	2xUM-1/3pin
MCF 70.0-25.06	70.0	6	6.0	1.0	±12.5	60 ±50	50 // 0	KF 13
MCF 70.0-50.06	70.0	6	5.0	2.0	±25	70 ±120	50 // 0	KF 13
MCF 70.455-0807	70.455	4	4.5	1.0	±4.0	40 ±20	50 // 0	KF 13
MCF 70.455-4007	70.455	4	6.0	1.0	±2.0	40 ±75	50 // 0	KF 13
MCF 85.0-7.504	85.0	4	5.0	1.0	±3.75	50 ±22.5	1200 // 0	2xUM-1/3pin
MCF 100.0-15.02	100.0	2	2.0	1.0	±7.5	15 ±25	1450 // -1.2	UM-1/3pin
MCF 121.0-15.08	121.0	8	8.0	2.0	±7.5	70 ±30	50 // 0	KF 17
KE 169.75-4004	169.750	4	7.0	2.0	±20.0	40 ±80	50 // 0	KF 13
KE 172.955-4004	172.955	4	7.0	2.0	±20.0	40 ±80	50 // 0	KF 13

Metal packages for crystal filters

We offer standard types of metal cases, custom cases for the filters can be used as well

Examples of standard metal packages

HC-49 case

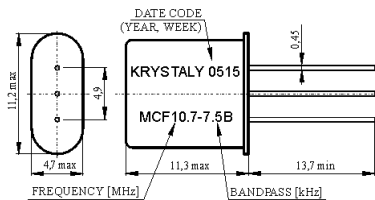

HC-45 case

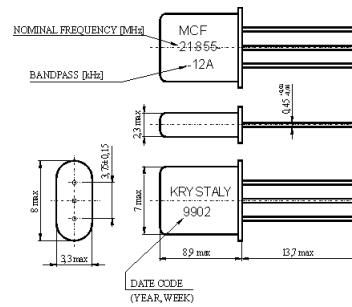

UM-5 case, SMD modification

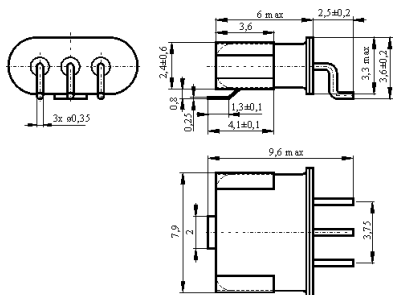

KF-17.5 SMD case

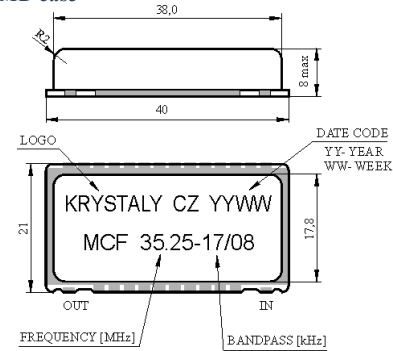

KF-13 case

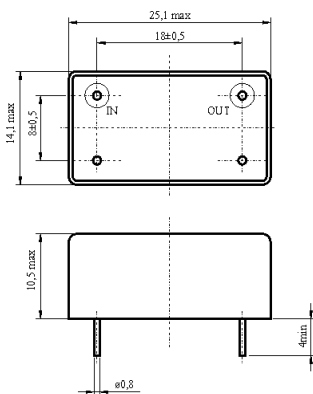

KF-17 case

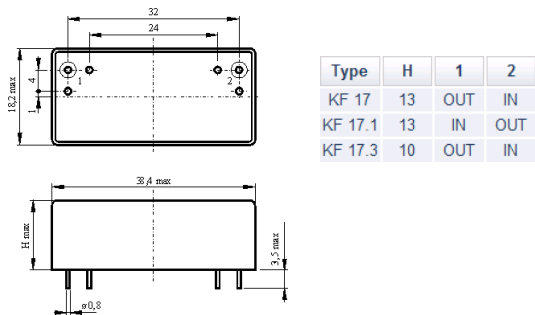

KV 2.1 case

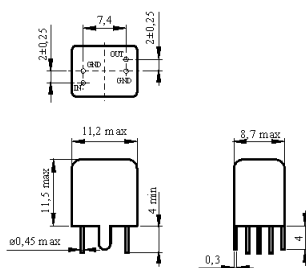

KV 3 case

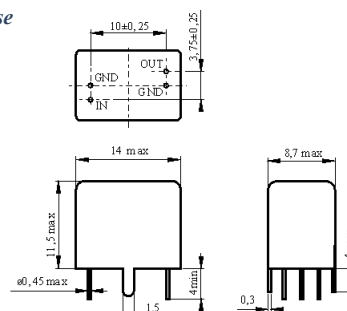



www.krystaly.cz

Okružní 1144
Hradec Králové
Czech Republic

krystaly@krystaly.cz
Tel. +420 495 408 409

KRYSTALY, Hradec Králové, a.s.

KA 2 case

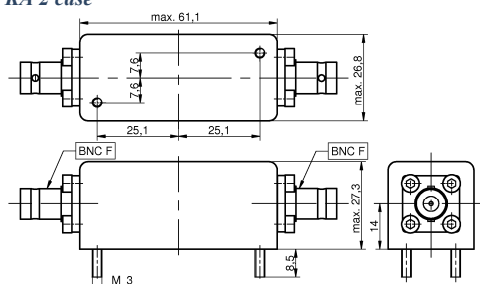

KA 21 case

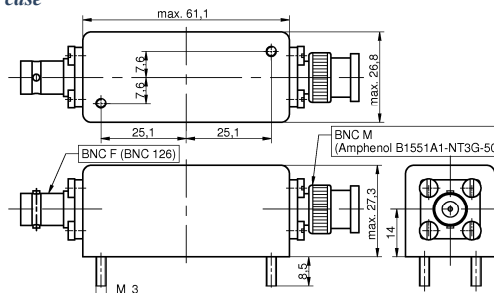

KA 3 case

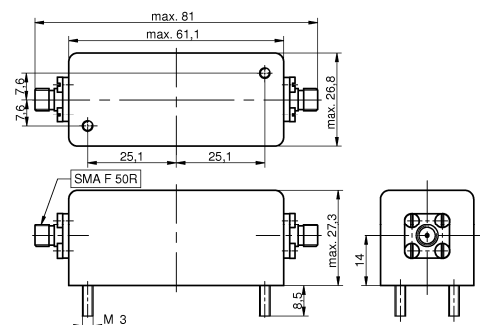

KA 4 case

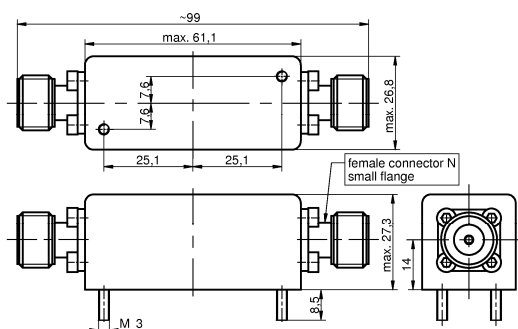

KA 41 case

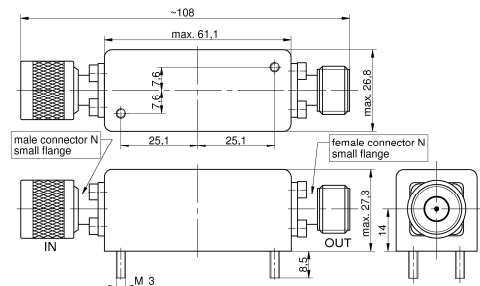

KA 5 case

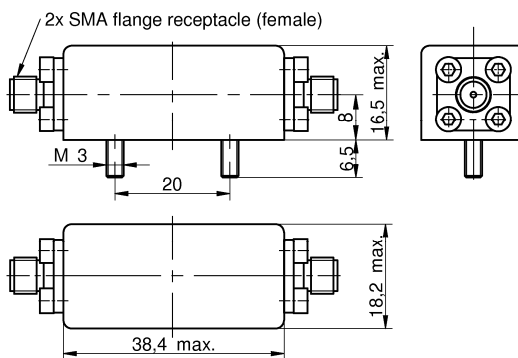

KA 7 case

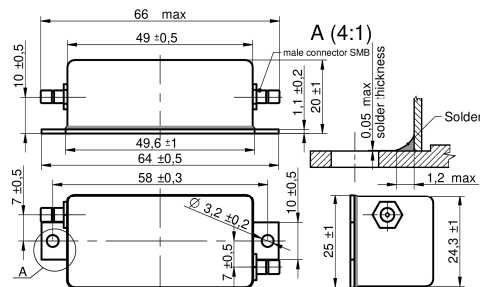

KA 72 case

